

Baujahr 2013 - 2015

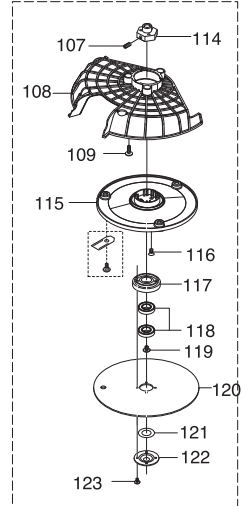



Bild Nr. Picture No.	Ersatzteil-Nr. Spare Part No.	Bezeichnung	Description	Désignation
Art. 4072-20 A		Mähroboter R70Li	Robotic Lawnmower R70Li	Tondeuse robot R70Li
Art. 4069-20 A		Mähroboter R80Li	Robotic Lawnmower R80Li	Tondeuse robot R80Li
1	57-55.433.14	Schraube grau (14mm)	Screw grey (14 mm)	Vis gris (14 mm)
2	2648-00.600.80	Schriftzug Gardena	Decal, GARDENA logotype	Étiquette adhésive GARDENA
3	57-93.921.05	Blende, kpl.	Plate kit	Écran, cpl.
4	57-77.076.03	Rahmen	Frame	Cadran
5	57-77.073.03	Gehäuseschale	Housing	Carter
6,16	57-62.139.01	Schraube M5x12, verzinkt	Screw M5x12, zincked	Vis M5x12, zingué
7	57-44.690.02	Halter vorne	Bracket front	Support avant
8,19	57-44.691.02	Gummidämpfer	Rubber damper	Amortisseurs en caoutchouc
9	57-44.851.02	Feder	Spring, lift sensor	Ressort
10	58-09.276.01	Typschild R70 Li	Decal R70 Li	Étiquette adhésive R70 Li
10	58-70.435.02	Typschild R80 Li	Decal R80 Li	Étiquette adhésive R80 Li
11	57-93.917.02	Gehäuse	Housing	Carter
12	58-63.597.01	Warnschild	Warning label	Warning sign
13	57-55.433.14	Schraube grau (14mm)	Screw grey (14 mm)	Vis gris (14 mm)
14	57-60.301.01	Platte Stoßsensor	Plate, collision sensor	Plaque pour senseur de chocs
15	57-61.833.01	Magnet Stoßsensor	Magnet, collision sensor	Aimant pour senseur de chocs
17	57-54.160.02	Aufnahme	Support clamp	Admission
18	57-55.433.14	Schraube grau (14mm)	Screw grey (14 mm)	Vis gris (14 mm)
20	57-61.832.01	Magnet Hebesensor	Magnet, lift sensor	Aimant pour senseur de levée
21	57-77.065.01	Stoßleiste	Bumper	Bumper
22	57-55.433.14	Schraube grau (14mm)	Screw grey (14 mm)	Vis gris (14 mm)
23	57-79.553.09	Gehäuse, kpl. -ohne Typschild-	Housing, cpl. -without decal-	Carter, cpl. -sans étiquette adhésive-
30	57-93.919.03	Obergehäuse, kpl.	Upper housing, cpl.	Carter supérieure, cpl.
31	57-77.072.01	Abdeckung	Cover	Couvercle
32	57-77.078.01	Scharnier	Hinge	Charnière
33	57-55.433.14	Schraube grau (14mm)	Screw grey (14 mm)	Vis gris (14 mm)
34	57-84.452.01	Feder	Spring	Ressort
35	57-77.066.01	Stoptaste	Stop button	Gâchette stop
36	57-44.870.01	Feder	Spring	Ressort
37	58-69.456.02	Tastatur	Keyboard display	Keyboard
38	57-55.433.14	Schraube grau (14mm)	Screw grey (14 mm)	Vis gris (14 mm)
39	57-44.803.01	Microschalter	Micro switch	Micro-contact
40	57-44.759.01	Lautsprecher	Buzzer	Haut-parleur
42	57-55.433.14	Schraube grau (14mm)	Screw grey (14 mm)	Vis gris (14 mm)
43	57-54.158.01	Federaufnahme	Springholder	Porte-ressort
44	57-62.422.01	Feder	Spring	Ressort
45	57-54.090.01	Verschluss	Lock	Bouchon
46-50	57-93.919.03	Obergehäuse, kpl.	Upper housing, cpl.	Carter supérieure, cpl.
47	57-55.433.14	Schraube grau (14mm)	Screw grey (14 mm)	Vis gris (14 mm)
48	57-66.970.01	Abdeckung	Cover	Couvercle
49,50,73,74	58-84.070.01	Dichtungssatz	Washer set	Jeu de joints
51	57-60.539.01	Abdeckung	Cover	Couvercle
52	57-55.433.14	Schraube grau (14mm)	Screw grey (14 mm)	Vis gris (14 mm)
53	57-93.922.01	Knopf	Knob	Bouton
54	57-62.139.01	Schraube M5x12, verzinkt	Screw M5x12, zincked	Vis M5x12, zingué
55	57-44.501.01	Schraube schwarz	Screw black	Vis noir
		<u>Baujahr 2013 - 2014</u>	<u>Year of construction 2013 - 2014</u>	<u>Année de fabrication 2013 - 2014</u>
		<u>Seriennummer 144499999</u>	<u>Serial number 144499999</u>	<u>Numéro de série 144499999</u>
5	57-77.073.01	Gehäuseschale	Housing	Carter
11	57-93.917.01	Gehäuse	Housing	Carter
		Nur die aufgeführten Teile sind lieferbar!	Only the mentioned spare parts are available!	Seules les pièces indiquées sont disponibles!

Bild Nr. Picture No.	Ersatzteil-Nr. Spare Part No.	Bezeichnung	Description	Désignation
Art. 4072-20 B Art. 4069-20 B		Mähroboter R70Li Mähroboter R80Li	Robotic Lawnmower R70Li Robotic Lawnmower R80Li	Tondeuse robot R70Li Tondeuse robot R80Li
60	57-77.079.01	Radkappe	Hub cap	Enjoliveur de roue
61	57-62.139.02	Schraube M5x12	Screw M5x12	Vis M5x12
62	57-70.932.01	Scheibe	Washer	Disque
63	57-44.651.04	Antriebsrad	Wheel	Roue
64	57-55.433.14	Schraube grau (14mm)	Screw grey (14 mm)	Vis gris (14 mm)
65	57-78.399.04	Radmotor inkl. Dichtung	Wheel motor assy.	Moteur de roue cpl.
67/71	53-51.303.10	Schraube (10mm)	Screw (10mm)	Vis (10mm)
68	57-62.202.01	Verkabelung Lautsprecher	Wiring loud speaker	Câblage pour haut-parleur
69	58-88.327.01	Verkabelung Display	Wiring display	Câblage pour display-unit
70	58-89.012.01	Verkabelung Hebesensor	Wiring lift sensor	Câblage pour senseur de levée
72	58-85.721.01	Sensorplatine	Printed circuit assy.	Platine électronique, sensor
49,50,73,74	58-84.070.01	Dichtungssatz	Washer set	Jeu de joints
75	57-43.737.01	Dichtung	Gasket	Joint
76	57-44.798.01	Verkabelung Batterie	Wiring battery	Câblage pour batterie
77	57-45.019.01	Führungsschiene	Guide rail	Glissière
78	57-44.846.01	Schraube	Screw	Vis
79	57-54.082.01	Verschlußkappe	Lock	Bouchon
80	57-71.032.01	Sicherungsfeder	Locking spring	Ressort d'arrêt
81	57-78.462.02	Untergehäuse kpl.	Bottom housing assy.	Carter inférieure cpl.
82	57-62.139.01	Schraube M5x12, verzinkt	Screw M5x12, zincked	Vis M5x12, zingué
83	57-44.777.02	Verkabelung Ladeblech	Wiring charge plate	Câblage pour élément de contact
84	57-55.433.14	Schraube grau (14mm)	Screw grey (14 mm)	Vis gris (14 mm)
85	53-50.874.01	Zahnscheibe	Tooth lock washer	Disque dentée
86	57-44.900.02	Ladekontakt	Charge plate	Élément de contact
87	57-97.087.01	On/Off Schalter	On/Off switch	On/Off interrupteur
88	57-44.672.02	Gehäuse Hinterrad	Housing rear wheel	Carter, roue arrière
89	57-55.433.14	Schraube grau (14mm)	Screw grey (14 mm)	Vis gris (14 mm)
90	58-38.539.02	Hinterradkit	Rear wheel kit	Roue arrière set
91	57-82.751.03	Hinterrad, kpl.	Rear wheel, cpl.	Roue arrière, cpl.
92	57-82.752.01	Hinterrad Lagerkit	Rear wheel kit	Roue arrière set
93	57-77.150.01	Hinterradlager	Bearing housing, rear wheel	Palier pour roue arrière
94	57-55.433.14	Schraube grau (14mm)	Screw grey (14 mm)	Vis gris (14 mm)
95	57-44.501.01	Schraube schwarz	Screw black	Vis noir
96	57-44.673.01	Batteriedeckel	Cover, battery	Couvercle de batterie
97	58-65.762.01	Batterie Li Ion 18 V	Battery, Lithium 18 V	Batterie Li Ion 18 V
100*	58-49.893.01	Messermotor	Blade motor	Moteur de lame
101	57-55.433.14	Schraube grau (14mm)	Screw grey (14 mm)	Vis gris (14 mm)
102	57-45.035.01	Höhenanzeige	Height indicator	Indicateur de la hauteur
103*	58-10.203.01	Motorgehäuse	Motor housing	Carter moteur
104*	51-00.195.01	Scheibe	Washer	Disque
105*	57-62.138.01	Schraube M4x12	Screw M4x12	Vis M4x12
106	57-43.735.01	Nabe	Hub	Moyeu
107	57-62.135.01	Sicherungsschraube	Safety screw	Vis de blocage
108	57-78.502.04	Messerschutz	Guard	Protecteur
109	57-55.433.14	Schraube grau (14mm)	Screw grey (14 mm)	Vis gris (14 mm)
110	57-44.871.01	Messerscheibe	Cutting disc	Plaque de coupe
111	4087-00.701.00	Ersatzmesser (9 St.) (Art. 4087-20)	Blades (9 pcs.) (Art. 4087-20)	Lame (9 pcs.) (Réf. 4087-20)
112	57-70.932.01	Scheibe	Washer	Disque
113	57-62.138.01	Schraube M4x12	Screw M4x12	Vis M4x12
		<u>Baujahr 2013 - 2015</u>	<u>Year of construction 2013 - 2015</u>	<u>Année de fabrication 2013 - 2015</u>
		<u>Seriennummer 154499999</u>	<u>Serial number 154499999</u>	<u>Numéro de série 154499999</u>
69	57-44.792.01	Verkabelung Display	Wiring display	Câblage pour display-unit
70	57-44.790.01	Verkabelung Hebesensor	Wiring lift sensor	Câblage pour senseur de levée
72	57-56.409.01	Sensorplatine	Printed circuit assy.	Platine électronique, sensor
107	57-62.135.01	Sicherungsschraube	Safety screw	Vis de blocage
108	57-78.502.04	Messerschutz	Guard	Protecteur
109	57-55.433.14	Schraube grau (14mm)	Screw grey (14 mm)	Vis gris (14 mm)
114	58-07.931.01	Nabe	Hub	Moyeu
115	58-07.928.02	Messerscheibe	Cutting disc	Plaque de coupe
116	53-51.305.01	Schraube	Screw	Vis
117	53-51.264.01	Lagergehäuse	Bearing housing	Logement de palier
118	53-50.757.03	Kugellager	Ball bearing	Roulement à bille
119	53-50.760.01	Schraube	Screw	Vis
120	58-07.927.01	Gleitplatte	Skid plate	Plate glissant
121	53-50.825.01	Dichtung	Washer	Joint
122	53-50.815.01	Deckel	Cover	Couvercle
123	57-55.433.10	Schraube (10mm)	Screw (10mm)	Vis (10mm)

* Teile müssen immer zusammen getauscht werden! Es wird ein Softwareupdate benötigt für die Modelle 2011 - 2013, ab MSW 4.0 nicht

* Parts must always be replaced together! Software update is required for models 2011 - 2013, not needed for main software 4.0

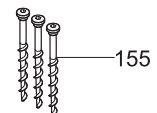
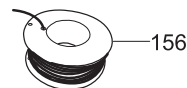
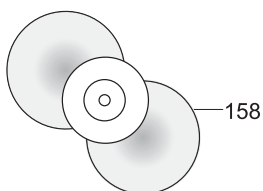
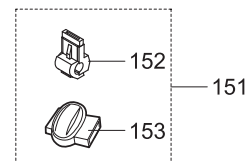
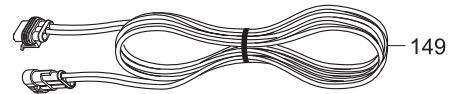
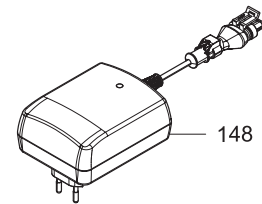
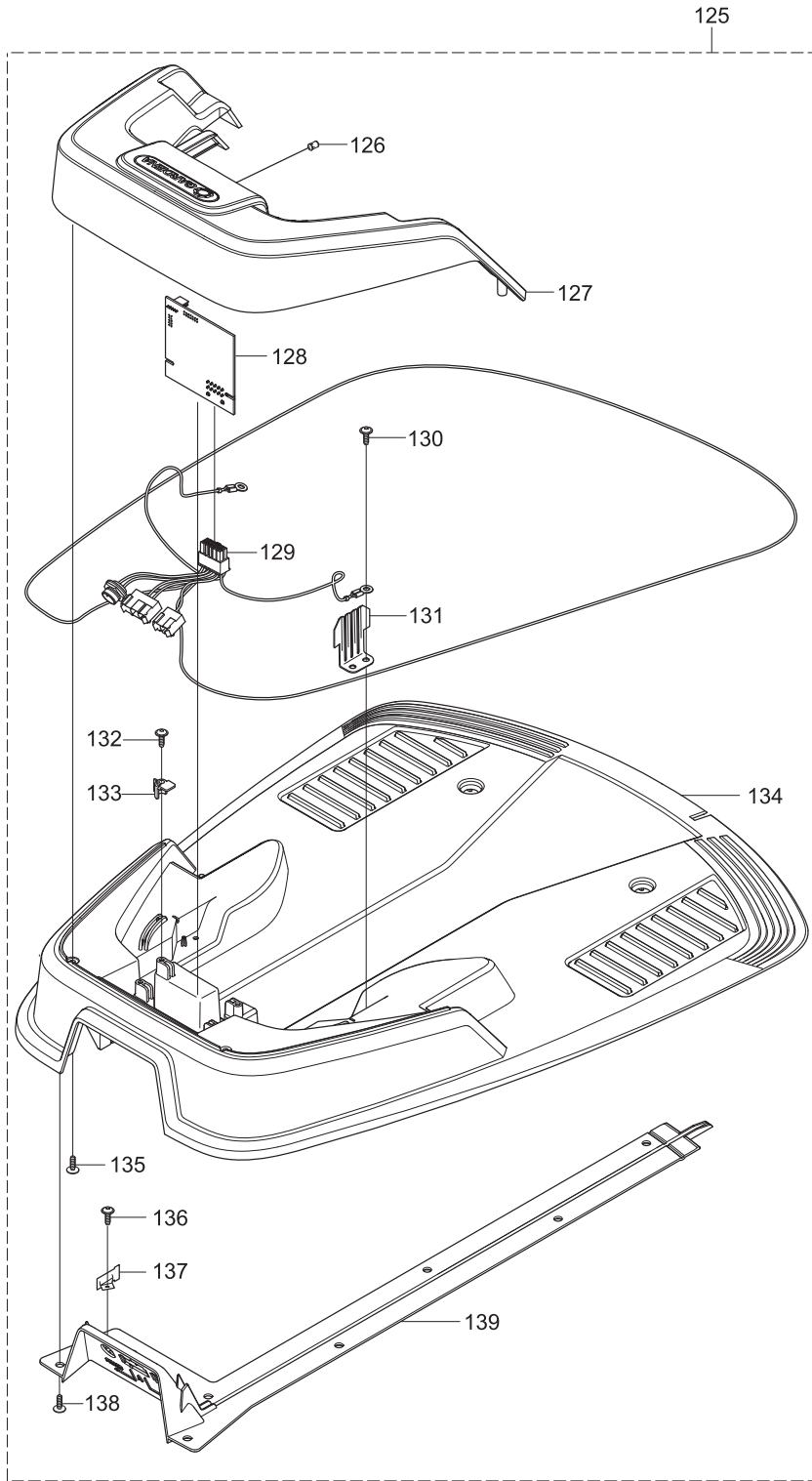
* Ces pièces doivent toujours être remplacées ensemble ! La mise à jour du logiciel est nécessaire pour les modèles de 2011- 2013, mais n'est pas nécessaire pour le logiciel principal à partir de la version 4.0

Nur die aufgeführten Teile
sind lieferbar!

Only the mentioned
spare parts are available!

Seules les pièces indiquées
sont disponibles!

Bild Nr. Picture No.	Ersatzteil-Nr. Spare Part No.	Bezeichnung	Description	Désignation
Art. 4072-20 C Art. 4069-20 C		Mähroboter R70Li Mähroboter R80Li <u>Ab Baujahr 2016</u> <u>ab Seriennummer 160100000</u>	Robotic Lawnmower R70Li Robotic Lawnmower R80Li <u>Since 2016</u> <u>since Serial number 160100000</u>	Tondeuse robot R70Li Tondeuse robot R80Li <u>À partir de 2016</u> <u>À partir de numéro de série 160100000</u>
125	57-79.723.09	Ladestation, vollst., 28 V	Charging station, cpl. 28 V	Station de Charge, cpl. 28 V
126	53-51.287.02	Linse	Diode lens	Lentille
127	58-46.183.01	Abdeckung	Cover	Couvercle
128	58-88.825.01	Platine Ladestation	Printed circuit assy.	Platine électronique, station de charge
129	58-84.903.02	Verkabelung Ladestation	Wiring, charging station	Câblage pour station de charge
130	57-55.433.14	Schraube grau (14 mm)	Screw grey (14 mm)	Vis gris (14 mm)
131	57-58.500.01	Ladekontakt	Contacts, charging station	Élément de contact
132	57-55.433.14	Schraube grau (14 mm)	Screw grey (14 mm)	Vis gris (14 mm)
133	53-51.279.01	Halter	Bracket	Support
134	58-15.519.02	Grundplatte Ladestation	Base plate charging station	Plaque de base pour station de charge
135	57-55.433.14	Schraube grau (14 mm)	Screw grey (14 mm)	Vis gris (14 mm)
136	57-55.433.14	Schraube grau (14 mm)	Screw grey (14 mm)	Vis gris (14 mm)
137	58-10.116.01	Halteklammer	Clamp	Clip de fixation
138	57-55.433.14	Schraube grau (14 mm)	Screw grey (14 mm)	Vis gris (14 mm)
139	58-10.117.01	Kabelführung	Cable guide	Guide-câble
145	11-57.069.51	Bedienungsanleitung	Operators manual	Mode d'emploi
146	11-57.244.51	Kurzanleitung	Quick guide	Instruction de service
148	58-48.625.01	Netzgerät EU 28 V	Power unit EU 28 V	Transformateur EU 28 V
148	58-48.626.03	Netzgerät CH 28 V	Power unit CH 28 V	Transformateur CH 28 V
149	57-98.251.03	Niederspannungskabel 3 m, 28 V	Transformer cable 3 m, 28 V	Câble basse tension 3 m, 28 V
149	57-98.251.02	Niederspannungskabel 10 m, 28 V	Transformer cable 10 m, 28 V	Câble basse tension 10 m, 28 V
149	57-98.251.01	Niederspannungskabel 20 m, 28 V	Transformer cable 20 m, 28 V	Câble basse tension 20 m, 28 V
151	4089-00.701.00	6 Verbinder + 2 Anschlussklemmen (Art. 4089-20)	6 Couplers + 2 Connectors (Art. 4089-20)	6 Connecteurs+ 2 Raccords de câble (Ref. 4089-20)
152	53-51.290.01	Anschlussklemme (1 Stk.)	Loop wire connector (1 pcs.)	Connecteur (1 pcs.)
153	50-19.802.01	Kabelverbinder (1 Stk.)	Splice kit (1 pcs.)	Raccords de câble (1 pcs.)
154	4090-00.701.00	Haken (100 Stück) (Art. 4090-20)	Staples (100 pcs.) (Art. 4090-20)	Cavaliers (100 pcs.) (Ref. 4090-20)
155	57-52.386.02	Schraube (3 Stk.) inkl. Imbusschlüssel	Anchor screw (3 pcs.) incl. allen key	Vis (3 pcs.) incl. clé Allen
156	4088-00.701.00	Begrenzungskabel 150 m (Art. 4088-20)	Loop wire 150 m (Art. 4088-20)	Câble périphérique 150 m (Ref. 4088-20)
156	58-06.620.03	Begrenzungskabel 200 m	Loop wire 200 m	Câble périphérique 200 m
156	58-06.620.01	Begrenzungskabel 250 m	Loop wire 250 m	Câble périphérique 250 m
157	57-89.106.01	Anti-Diebstahlaufkleber	Label, anti-theft	Étiquette adhésive anti-vol
158	57-89.091.04	Installations DVD	Installation DVD	DVD Installation
		<u>bis Baujahr 2013</u>	<u>until 2013</u>	<u>jusqu'à 2013</u>
	57-75.122.01	Mutter, selbstschneidend für Ladestation	Nut, self-tapping	Écrou taraudeur
		<u>Baujahr 2013 - 2015</u> <u>Seriennummer 130100000 – 155299999</u>	<u>Year of construction 2013 - 2015</u> <u>Serial number 130100000 – 155299999</u>	<u>Année de fabrication 2013 - 2015</u> <u>Numéro de série 130100000 – 155299999</u>
125	57-79.723.05	Ladestation, vollst. 21,6 V	Charging station, cpl. 21,6 V	Station de Charge, cpl. 21,6 V
129	58-12.259.02	Verkabelung Ladestation	Wiring, charging station	Câblage pour station de charge
148	58-44.089.01	Netzgerät EU 21,6 V	Power unit EU 21,6 V	Transformateur EU 21,6 V
148	58-11.451.03	Netzgerät CH 21,6 V	Power unit CH 21,6 V	Transformateur CH 21,6 V
149	58-11.666.03	Niederspannungskabel 21,6 V – 10 m	Transformer cable 21,6 V – 10 m	Câble basse tension 21,6 V – 10 m
149	58-11.666.04	Niederspannungskabel 21,6 V – 20 m	Transformer cable 21,6 V – 20 m	Câble basse tension 21,6 V – 20 m
		Nur die aufgeführten Teile sind lieferbar!	Only the mentioned spare parts are available!	Seules les pièces indiquées sont disponibles!